

Model: KB1700

Programmable Keypad

176 Programmable Keys

USER MANUAL



NOTICE

The manufacturer of the POS programmable keypad makes no representations or warranties, either expressed or implied, by or with respect to anything in this manual, and shall not be liable for any implied warranties of fitness for a particular purpose or for any indirect, special or consequential damages. Information in this document is subject to change without notice and does not represent a commitment on the part of the manufacturer.

FCC NOTICE

This device complies with Part 15 of FCC Rules. Operations is subject to the following two conditions: (1) this device may not cause harmful interference. and (2) this device must accept any interference received, including interference that may cause undesired operation.

LOGIC CONTROLS, INC.
355 Denton Ave
New Hyde Park, NY 11040
TEL: (516) 248-0400
FAX: (516) 248-0443
Email: lci@logiccontrols.com
<http://www.logiccontrols.com>

TABLE OF CONTENTS

FEATURES	1
CARTON CONTENTS	2
HARDWARE CONNECTIONS	3
FUNCTIONAL TEST	5
UTILITY DISK CONTENTS	7
INSTALLING THE KB17.EXE UTILITY PROGRAM	8
STARTING THE KB17.EXE PROGRAM	8
PROGRAMMING THE KB1700 KEYPAD	10
ADVANCED PROGRAMMING	12
SPECIAL FEATURES OF THE KB1700	13
INTER-STRING DELAY	13
MULTI-LEVEL DEFINITION	14
SELF PROGRAMMING	16
SPECIAL CONFIGURATIONS	17
DATA TRANSFER MENU	19
PINOUTS	21
SPECIFICATIONS	22

FEATURES

- Fully downward compatible with the IBM Bump Bar
- All 17 keys are programmable, up to 119 characters per key
- Keypad I/O ports allow daisy-chaining of input devices
- Programmable inter-string delay
- Stainless steel dome disk switches
- Standard computer 101 keyboard output data format
- Output data set includes all alphanumeric, controls, and function codes
- Optional international output codes (Alt-Number)
- True keyboard wedge function, operates with or without computer keypad
- Internal beeper
- No programming accessory kit, TSR program, or battery required
- Available with RS232C output

CARTON CONTENTS

KB1700

1. Keypad, Model KB1700
2. Interface cable to computer
3. Interface cable to 101 keyboard
4. Utility software disk
5. Legend label sheet
6. User's manual

HARDWARE CONNECTIONS

The KB1700 can be connected to an IBM101 PC, XT, AT or clone computer, PS/2 computer, or computer terminal. The following diagram shows how the KB1700 connects to the computer and standard keypad or other keypad peripheral (magnetic stripe reader, scanner, etc.).

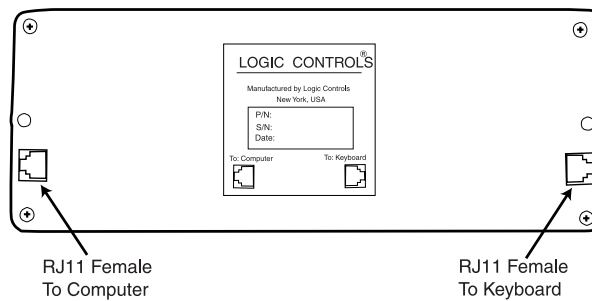

NOTE: Before making any connections it is always advisable to turn off the computer.

A. Connecting the KB1700 to an IBM101 PC, XT, AT, or clone computer's keypad port:

1. Use the computer interface cable. Plug the AT or PS/2 Male connector plugs into the computer. Connect the RJ11 connector into the "To Computer" connector on the KB1700.
2. Connect the keypad interface cable to the standard keyboard. The AT or PS/2 Female connector plugs into the standard keyboard. The RJ11 connector plugs into the "To Keyboard" connector on the back of the KB1700.

FUNCTIONAL TEST

For testing purposes, your KB1700 keypad was pre-programmed with a template called **LC.tpl**. The following simple steps will verify that the KB1700 is in good working condition:

1. Follow the Hardware Connections procedure described earlier in this manual to connect the KB1700 to your computer.
2. Turn on your computer.
3. At the DOS prompt, press the upper left key of the keypad.
4. The keypad is working correctly when the words "LOGIC CONTROLS PROGRAMMABLE KEYPAD, MODEL KB1700" appears on the monitor. To verify if the other keys are working simply press each key and verify that the information displayed on the monitor matches the template shown at the end of this section.

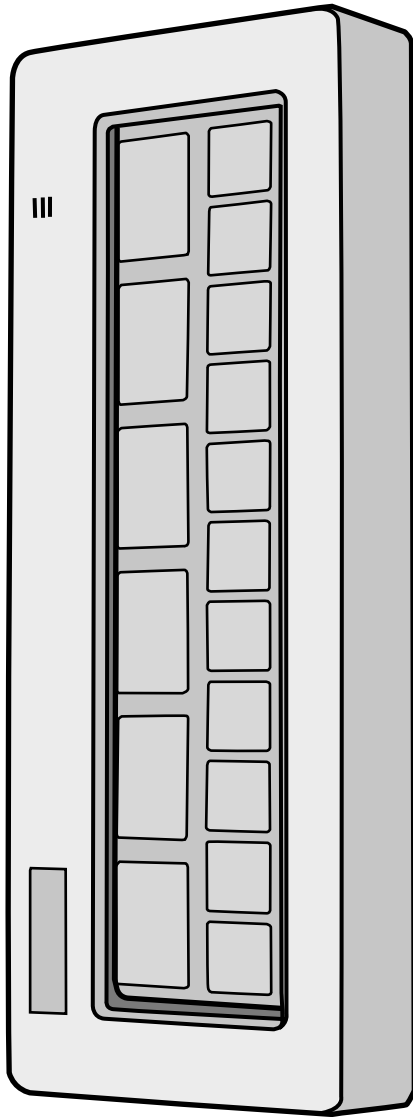

UTILITY DISK CONTENTS

All KB1700 keypads come with a utility software disk. This disk contains several important files:

- KB17.EXE -** Use this utility with or without the keypad being attached. It is used to program the keypad. For a complete description of how this program works see the section "Programming the KB1700 keypad".
- LC.TPL -** This template was pre-programmed into the keypad and matches the legend shown on the previous page. If you have any questions on how to program a particular key you can refer back to this template to see how it was originally programmed.
- MANUAL.PDF-** KB1700 manual

INSTALLING THE KB17.EXE UTILITY PROGRAM

The first step in using the KB17.EXE utility program is to copy the program to your hard drive.

1. Insert the KB1700 utility software into drive A or B of the computer.
2. Type **MD KB17** at the "C>" prompt to make a directory named KB17.
3. Type **CD KB17** to make the KB17 directory active.
4. Type **COPY A:*.*** If the disk was inserted into drive A then all files will be copied into the hard drive's directory (KB17). If drive B is used then you must type **COPY B:*.***

STARTING THE KB17.EXE PROGRAM

This program can be used with or without the keypad being attached to the computer. To start the program type **KB17** at the KB17 DOS prompt and press **ENTER**. When the 101 keyboard is used by itself, the program will acknowledge that no keypad is attached by displaying a "No POS keypad found" message. To continue using the program you must select one of the choices shown. If the keypad is attached, the program will automatically select the correct programming graphics screen for you.

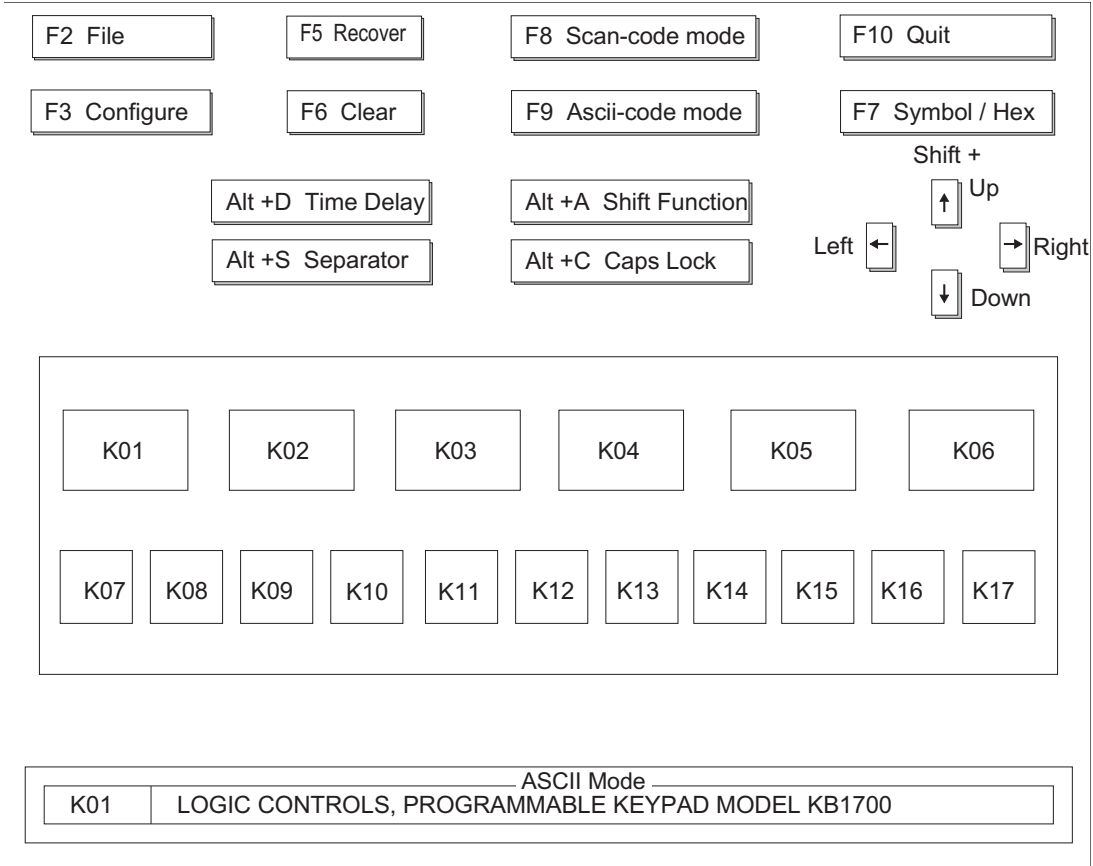

PROGRAMMING THE KB1700 KEYPAD

The following procedure will show you how to program your KB1700 with standard (keyboard) alphanumeric characters. The keypad can be programmed with either ASCII or Scan code information. The default mode is the ASCII code mode. The following procedure assumes both a KB1700 keypad and a 101 keyboard are attached.

NOTE: To run this program you must exit windows completely. Do not shell out from Windows.

1. With the correct programming graphics present. Select the cell you want to program by using the arrow keys on the 101 keyboard. The Up and Down arrows will select the row while the **Shift** and either the **Right** or **Left** arrow key will select the column.
2. Enter your programming text via the 101 keyboard. Continue programming until all the keys are programmed. It is not necessary to program all the keys for the KB1700 to function properly. The maximum number of alphanumeric characters that can be programmed for any one key is 119.

NOTE: The maximum number of alphanumeric characters that can be programmed per standard keypad is approximately 1900.

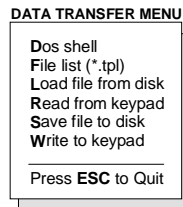

3. Press **F2** to call up the Data Transfer Menu. There will be several choices to choose from.
4. Type **W** to write the programmed data into the KB1700's non volatile memory. A "Writing Data" screen will open showing the percentage of memory written. It will take approximately 7 seconds

to copy the data into the keypad.

5. Type **S** to save the programmed data into the KB17 directory. You can select up to an 8 character name. It will be saved with a **.TPL** extension.
6. Press **ESC** to terminate the Data Transfer Menu.
7. Press **F10** followed by **Y** to exit the utility program.
8. To verify that your program has been successfully installed, simply press any programmed key. The information stored in that key will appear on the monitor.
9. The next time you want to install the legend you just created simple press **F2** to call up the Data Transfer Menu and then press **L** to open the Load window.
10. Enter the name of the file in the legend window with its proper extension (.TPL) and press ENTER. The legend will now show on your monitor.

ADVANCED PROGRAMMING

The KB1700 POS keypad can be programmed with all special control and function keys such as the **Shift, Ctrl, Alt, F1** through **F12**, and the **up/down/left/right** arrow keys. The procedure to program these special keys is shown below:

1. Start the KB17 utility program.
2. Select the cell to be programmed. Press **F8** to enter the scan-code mode. The "code type" information changes from **ASCII** to **SCAN**.

NOTE: The scan-code mode will only be active for this cell. You must select F8 for each cell you want to program with scan-code information.

3. Under the scan-code mode, each alphanumeric character is enclosed in parenthesis. For special function or control keys, press **ESC** (three vertical bars will be present) followed by the special function or control key you want to program.

For example, to program the **INS** (insert) key, press **ESC** and then the **INS** key on the 101 keyboard. To program the **ESC** key, simply press the **ESC** key twice. Special function and control keys will **not** appear inside parenthesis. The three vertical bars will disappear once the special function key is depressed.

4. You may return to the start-up graphic screen (short menu) by pressing **Ctrl-Alt-F4** again.

NOTES:

- 1) Special function keys require ESC as the leading code. In the scan-code mode, you can view the symbol of the special key or the hex code equivalent of the special key. To view, simply press **F7** to toggle between symbol and hex modes.
- 2) Once a special function key (shift, ctrl, alt, etc.) is programmed it may be necessary to un-select the function. To do so, press in sequence **ESC, f** (lower case F), **0** (zero), **ESC**, followed by the special function key (shift, ctrl alt, etc.)
- 3) Any given programmable location may be toggled between scan-code mode and ASCII-code mode. Pressing the **F8** key on the keyboard will change the cell's programming mode to scan-code mode. Pressing **F9** on the keyboard will change the cell's programming mode to ASCII-code mode. Changing modes in a cell that has been previously programmed will erase all the information in that cell.
- 4) To enter hex scan-codes directly, press **ESC** followed by the 2-digit hex number. For example, to program the **CTRL** key press **ESC** followed by **1D**. The KB17 program will add the leading zero

SPECIAL FEATURES OF THE KB1700

Besides being able to program all the keys of an IBM101 keyboard, the KB1700 has also incorporated three state-of-the-art features which will add flexibility and functionality to the keypad.

INTER-STRING DELAY

This feature allows for a time delay(s) to be installed after a character(s) has been inserted into a cell. To use this feature follow the steps below:

1. Enter the character(s) which will precede the delay. For example, **ABC**.
2. Depress and hold the **ALT** key while pressing the letter **D**. A time delay screen will open asking for the amount of delay you require (up to 240 seconds). Select the appropriate delay and press **ENTER**. A square pixel will appear on the programming line immediately following the last character typed.
3. Type the next character(s), **DEF**. You can use more than one delay per cell and each delay time can be different.
4. Save the template and then write the template to the keypad.
5. Exit the KB17 program by pressing **F10** followed by the letter **Y**.
6. Press the location key where the time delay character has been stored. The monitor will display **ABC** immediately. After the delay time you entered for this key has expired, **DEF** will be displayed on the monitor and the cursor will be present at the prompt.

MULTI-LEVEL DEFINITION

This feature can increase the apparent number of programmable keys by allowing you to program different levels into any cell. For every different level you program you must select another key to be a "SHIFT LEVEL" key. Programming is accomplished in the normal manner. After programming the base level a separator bar must be entered to separate the base level from the second level. You can program more than two levels per cell. For example, if you needed to program small coffee, medium coffee, and large coffee into one cell follow the procedure outlined below:

1. Select a blank cell and enter the most common coffee first (**medium coffee**). Mark the legend sheet for this cell **COFFEE**.
2. Enter the separator bar by depressing and holding the **ALT** key and pressing the letter **S**. A solid line will appear on the programming line immediately following the last character typed.
3. Enter the second level (**small coffee**) followed by another separator.
4. Enter the third level of information (**large coffee**). The entire programming line should look like the following:

K01

MEDIUM COFFEE	SMALL COFFEE	LARGE COFFEE
---------------	--------------	--------------

5. Select a blank location to become the first level shift position. Mark the legend sheet for this location **SMALL**.
6. Change the programming mode of this cell to scan-code mode (**F8**). Depress and hold the **ALT** key while pressing the letter **A**. A triangle inside brackets (< >) will appear on the programming line. This key when depressed and held will activate all keys that have a second level.
7. Select another blank location . This will become the second level shift position (will activate the third level of information). Mark the legend sheet for this position **LARGE**.

8. Change the programming mode of this cell to the scan-code mode (**F8**). Depress and hold the **ALT** key while depressing the letter **A** twice. Two triangles inside brackets will appear on the programming line.

9. To use this feature in your application is extremely simple. When medium coffee is desired just press the **K01** key (the first level of information stored in cell **K01** will be sent to the computer). When a small coffee is desired press and hold the **K02** key while pressing the **K01** key (the second level of information stored in cell **K01** will be sent to the computer). When a large coffee is desired press and hold the **K03** key while pressing the **K01** key (the third level of information stored in cell **K01** will be sent to the computer)

NOTE: There is no preset limit to the number of levels that can be programmed into a keypad.

SPECIAL CONFIGURATIONS

The KB1700 can be set up with many different programming options. To activate the configuration menu screen the KB17 program must first be placed into the extended menu (**Ctrl, Alt, F4**). Press **F3** to open the configuration screen. By depressing the highlighted letter in each option the program will enable or disable that option. The default settings are shown in the graphic below.

Send B reak-codes for scan-codes	Yes
Enable beep while a key pressed	Yes
N o beep if a key is undefined	Yes
Translate to code-set #2 for AT	Yes
Emulating X T keyboard always	No
Use A LT+num to generate ASCII	No
Enable Typematic for scan codes	No
Enable Typematic for ASCII codes	No
Emulating Link Terminal	No
InterCharacter Delay (+/-):	<input type="text" value="2"/> mS
Enable RS232 Output	<input type="text" value="No"/>
Baud Rate:	<input type="text" value="9600"/>
Parity:	<input type="text" value="NONE"/>
Length of Data:	<input type="text" value="8"/> -bits
<input type="text" value="Press a High-light Letter to select"/>	
Esc ==> Quit from this menu	

DESCRIPTION OF SPECIAL CONFIGURATION MENU F3

Send Break-code for scan-codes - Enables or disables the transmission of break codes for each scan code programmed into the keypad.

Enable beep while a key pressed - Enables or disables the entire keypad from beeping when any key is depressed.

No beep if a key is undefined - If a key is not programmed it will not beep when depressed.

Translate to code set #2 for AT - Enables or disables the output of the keypad to be translated into AT scan code.

Emulating XT keypad always - Enables or disables the output of the keypad to be translated into XT scan code.

Use ALT +num to generate ASCII - Enables or disables the ability to use the ALT key along with the numeric keypad to generate ASCII codes.

Enable typematic for scan codes - Enables or disables keys programmed with scan code information to repeat the programmed characters as long as the key remains depressed.

Enable typematic for ASCII codes - Enables or disables keys programmed with ASCII code information to repeat the programmed characters as long as the key remains depressed.

Emulating Link Terminal - Enables or disables the keypads ability to emulate a link terminal.

Intercharacter Delay (+/-) - The time delay between characters can be adjusted from 1 millisecond to 266 milliseconds. This delay is set for all characters programmed into the keypad. Do not confuse this feature with the inter-string delay feature.

DESCRIPTION OF SPECIAL CONFIGURATION MENU F3 (CONTINUED)

Enable RS232 Output - Enables or disables the output of the keypad to the RS232 port (DB9 connector). If this option is set to YES then the protocol settings must be set to mirror the application software.

Baud Rate - This option selects 2400, 4800, 9600 and 19,200 baud rates.

Parity - This option selects ODD, EVEN or NO parity.

Length of data - This option selects either 7 or 8 data bits.

DATA TRANSFER MENU

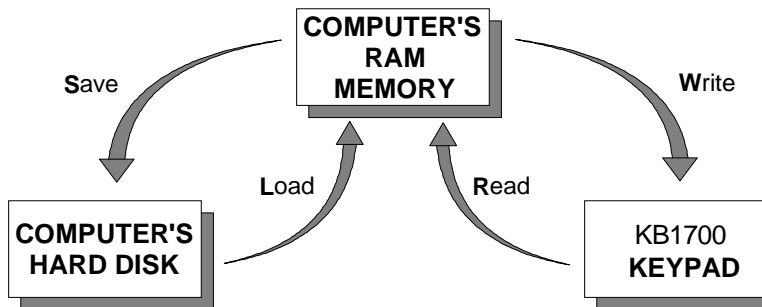

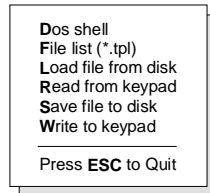

The KB1700 keypad, working in conjunction with the KB17.EXE utility software, can perform the following powerful functions:

- * Save programmed data as a template file (.TPL) in both the keypad and the hard drive of the computer. To save programmed data to the keypad use the **W** (Write to keypad) option of the Data Transfer Menu. To save programmed data to the hard drive use the **S** (Save file to disk) option of the Data Transfer Menu.
- * Load (**L**) a previously programmed template from the hard disk into the computer's volatile RAM memory. The same template can then be written (**W**) into the non-volatile memory of the KB1700. This process, as an example, allows a restaurant to change from a breakfast menu to a lunch menu within 7 seconds.
- * Enables the computer to read (**R**) a template stored in the KB1700. That template can then be saved (**S**) to the hard disk for future use.
- * Display a list of templates that have been stored onto the hard disk within the KB17 directory. From the Data Transfer Menu select **F** for File List. The computer's monitor will display the list of .TPL files stored in the KB17 directory.
- * Interruption of the programming process to shell out to DOS (**D**) to perform other operations. To return to the programming process type **EXIT** at the DOS prompt.

NOTE: Never shell out of windows to work in this utility program.

KB1700 PROGRAMMABLE KEYPAD SPECIFICATIONS

MECHANICAL

Weight Without Bracket	0.70 lbs.
Weight With Bracket	1.40 lbs.
Dimension Without Bracket Attached (in inches)	
Width	9.25
Height	3.50
Depth	1.13
Dimension With Bracket Attached (in inches)	
Width	9.25
Height	2.86
Depth	4.00
Keys	Stainless Steel Dome Disks
Life cycle	> 5 million tactile operations

PROGRAMMING THE KEYPAD

1. Use the utility software supplied with keypad to program up to 119 alphanumeric characters per key. Utility program will write to and read from computer disk memory.
2. Keypad supports special IBM 101 control keys (Shift, Ctrl, Alt, F1 through F12, and the up/down/left/right arrow keys).

ELECTRICAL

Input Voltage (from comp.)	+5VDC
Current	25 ma.

ENVIRONMENTAL

Operating Temperature	0 to +50 °C
Storage Temperature	-20 to +70 °C
Relative Humidity	
Operating	85% max., non-condensing
Non-operating	90% max., non-condensing
Vibration (10 to 55 Hz.)	4G's
Shock	40G's

CONNECTOR PINOUTS

J1 (RJ11 Female) to Computer

- | | |
|---|----------------|
| 1 | Keyboard Clock |
| 2 | CPU Data |
| 3 | No Connection |
| 4 | Ground |
| 5 | +5VDC |
| 6 | Chassis Ground |

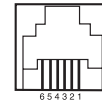

J2 (RJ11 Female) to 101 Keyboard

- | | |
|---|----------------|
| 1 | Keyboard Clock |
| 2 | Data |
| 3 | No Connection |
| 4 | Ground |
| 5 | +5VDC |
| 6 | Chassis Ground |

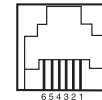

INTERFACES

Keyboard Emulation	Standard
RS232C (KB1701)	
Baud Rate	9600
Parity	None
Data Bit	8

GENERAL INFORMATION

Manual, programming cables, programming software, and mounting bracket supplied

